



## Acoustically insulated fans

### Flüsterventilatoren



Kanal-, Akustik-Ventilatoren, die für Lüftungs- und Klimaanlage bestimmt sind, werden an Luftführungskanäle angeschlossen. Sie werden für Zuluft und - Abluft verwendet. Nicht geeignet für die Beförderung von verschmutzter Luft, aggressiven, explosiven Gasen.

Laufrad ist rückwärts gekrümmt, aus verzinktem Stahl

Der Motor: Außenrotor, integrierter Thermokontakt-Motorschutz, dauerhafte, keine Pflege erfordernde Lager

Das Gehäuse: aus verzinktem Blech, Gehäuserahmen aus Aluminiumprofil

Schallisolation: Steinwolle mit verstärkter Oberfläche, 25mm dick, nicht entzündbar

Niedriges Geräuschniveau



Acoustically insulated duct fans for ventilation and air conditioning systems. Used for the air supply or extract. Additional insulation of the fan box reduces noise level to the surroundings. Not suitable for polluted air, aggressive and explosive gases.

Impeller: wings curved backward, made of zincked steel.

Motor: external rotor, direct transmission, long-serving bearing with no maintenance requirements.

Housing: made of galvanized steel, housing frame made of aluminium profiles, perforated sheet, which reduces noise level in duct systems.

Sound insulation: rock wool, 25 mm thickness.

Low noise level.

#### Accessories



TGRV  
p. 153



TGRT  
p. 154



MTY  
p. 156

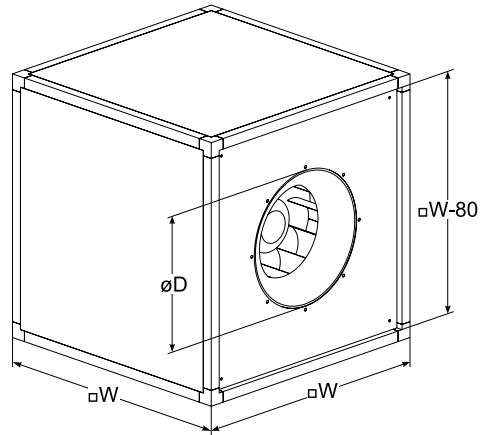

Type	Dimensions [mm]		
	$\varnothing D$	Nominal diameter of impeller- $\varnothing d_n$	$\square W$
KUB 355	292	355	500
KUB 400	325	400	670
KUB 450	365	450	670
KUB 500	410	500	670
KUB 560	460	560	800
KUB 630	510	630	800
KUB 710	580	710	1000

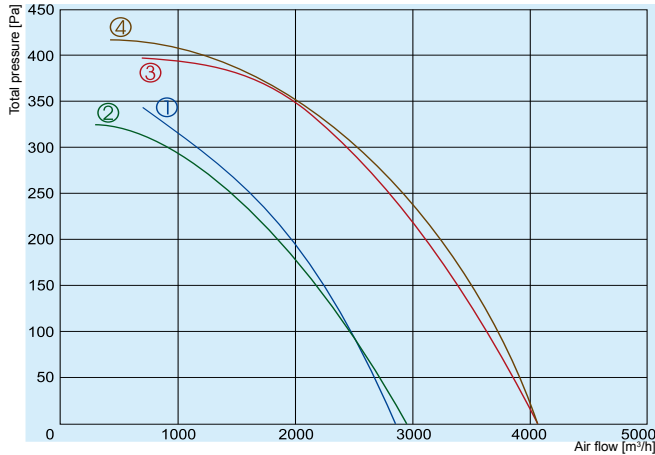

- ① — **KUB 355-4-L1**
- ② — **KUB 355-4-L3**
- ③ — **KUB 400-4-L1**
- ④ — **KUB 400-4-L3**

		<b>355-4-L1</b>	<b>355-4-L3</b>	<b>400-4-L1</b>	<b>400-4-L3</b>
Voltage/Frequency	[V/Hz]	230/50	400/50	230/50	400/50
Power consumption	[kW]	0,31	0,25	0,49	0,45
Current	[A]	1,45	0,47	2,20	0,86
Speed	[min <sup>-1</sup> ]	1360	1330	1350	1340
Max. airflow	[m <sup>3</sup> /h]	2850	2950	4100	4100
Max. air temperature	[°C]	65	60	40	55
Total sound power level at 1 m	[dBA]	71	68	70	69
Speed controller		TGRV2 / MTY2	TGRT1	TGRV3 / MTY4	TGRT1
Weight	[kg]	37	37	57	57
Wiring diagram		Nr. 1	Nr. 2	Nr. 1	Nr. 2
<b>Protection class:</b>	motor	IP-54	IP-54	IP-54	IP-54
	terminal box	IP-55	IP-55	IP-55	IP-55

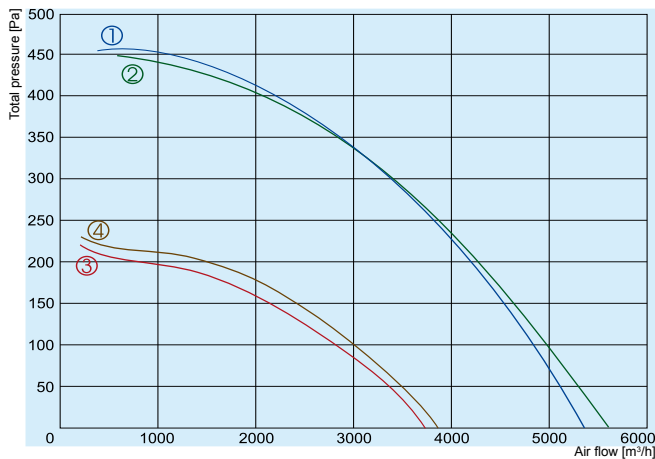

- ① — **KUB 450-4-L1**
- ② — **KUB 450-4-L3**
- ③ — **KUB 450-6-L1**
- ④ — **KUB 450-6-L3**

		<b>450-4-L1</b>	<b>450-4-L3</b>	<b>450-6-L1</b>	<b>450-6-L3</b>
Voltage/Frequency	[V/Hz]	230/50	400/50	230/50	400/50
Power consumption	[kW]	0,73	0,69	0,24	0,26
Current	[A]	3,30	1,30	1,05	0,63
Speed	[min <sup>-1</sup> ]	1230	1220	840	870
Max. airflow	[m <sup>3</sup> /h]	5400	5600	3750	3800
Max. air temperature	[°C]	60	40	60	60
Total sound power level at 1 m	[dBA]	74	75	67	67
Speed controller		TGRV4	TGRT2	TGRV1,5	TGRT1
Weight	[kg]	60	60	60	60
Wiring diagram		Nr. 1	Nr. 2	Nr. 1	Nr. 2
<b>Protection class:</b>	motor	IP-54	IP-54	IP-54	IP-54
	terminal box	IP-55	IP-55	IP-55	IP-55

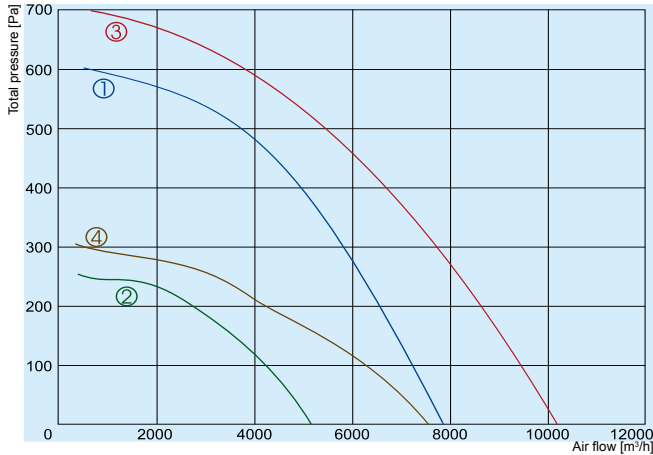

- ① — **KUB 500-4-L3**
- ② — **KUB 500-6-L3**
- ③ — **KUB 560-4-L3**
- ④ — **KUB 560-6-L3**

		<b>500-4-L3</b>	<b>500-6-L3</b>	<b>560-4-L3</b>	<b>560-6-L3</b>
Voltage/Frequency	[V/Hz]	400/50	400/50	400/50	400/50
Power consumption	[kW]	1,15	0,39	1,8	0,61
Current	[A]	2,10	0,81	3,40	1,05
Speed	[min <sup>-1</sup> ]	1340	850	1230	830
Max. airflow	[m <sup>3</sup> /h]	7850	5150	10200	7550
Max. air temperature	[°C]	45	45	40	40
Total sound power level at 1 m	[dBA]	77	66	79	68
Speed controller		TGRT3	TGRT1	TGRT4	TGRT2
Weight	[kg]	70	66	117	110
Wiring diagram		Nr. 2	Nr. 2	Nr. 2	Nr. 2
<b>Protection class:</b>	motor	IP-54	IP-54	IP-54	IP-54
	terminal box	IP-55	IP-55	IP-55	IP-55

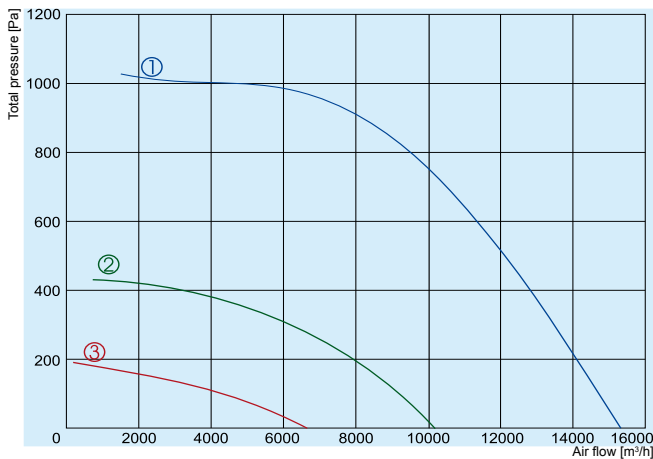

- ① — **KUB 630-4-L3**
- ② — **KUB 630-6-L3**
- ③ — **KUB 630-8-L3**

		<b>630-4-L3</b>	<b>630-6-L3</b>	<b>630-8-L3</b>
Voltage/Frequency	[V/Hz]	400/50	400/50	400/50
Power consumption	[kW]	4,0	1,05	0,38
Current	[A]	6,60	2,20	0,88
Speed	[min <sup>-1</sup> ]	1360	870	530
Max. airflow	[m <sup>3</sup> /h]	15600	10600	6650
Max. air temperature	[°C]	40	70	60
Total sound power level at 1 m	[dBA]	82	74	77
Speed controller		TGRT7	TGRT3	TGRT1
Weight	[kg]	145	130	120
Wiring diagram		Nr. 2	Nr. 2	Nr. 2
<b>Protection class:</b>	motor	IP-54	IP-54	IP-54
	terminal box	IP-55	IP-55	IP-55

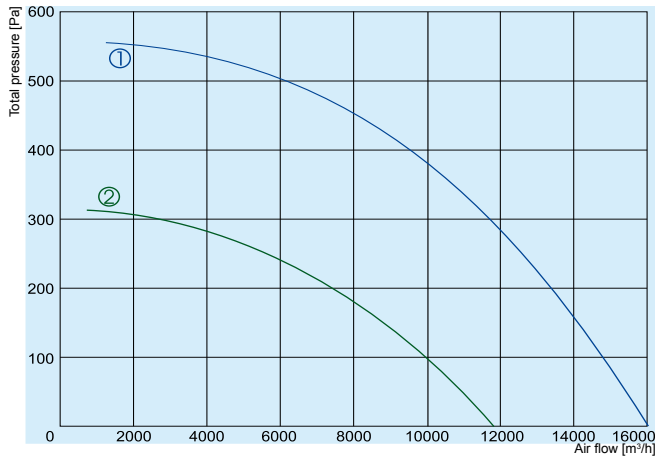

① — KUB 710-6-L3

② — KUB 710-8-L3

		710-6-L3	710-8-L3
Voltage/Frequency	[V/Hz]	400/50	400/50
Power consumption	[kW]	2,0	0,96
Current	[A]	3,90	1,90
Speed	[min <sup>-1</sup> ]	890	650
Max. airflow	[m <sup>3</sup> /h]	16000	11900
Max. air temperature	[°C]	40	40
Total sound power level at 1 m	[dBA]	78	70
Speed controller		TGRT5	TGRT2
Weight	[kg]	185	170
Wiring diagram		Nr. 2	Nr. 2
<i>Protection class:</i>	motor	IP-54	IP-54
	terminal box	IP-55	IP-55

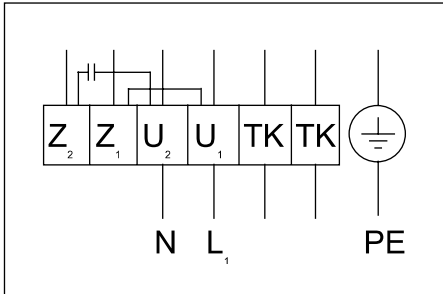

### Wiring diagram No. 1 (1~230V)

**U<sub>1</sub>** - brown  
**U<sub>2</sub>** - blue  
**Z<sub>1</sub>** - black  
**Z<sub>2</sub>** - orange  
**TK** - white  
**PE** - yellow-black

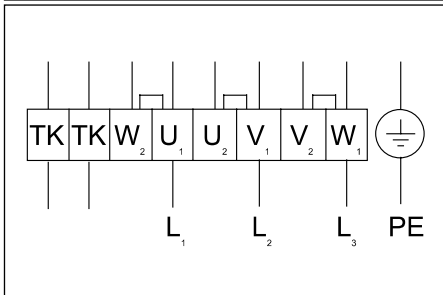

### Wiring diagram No. 2 (Δ - 3~230V)

**U<sub>1</sub>** - brown  
**V<sub>1</sub>** - blue  
**W<sub>1</sub>** - black  
**U<sub>2</sub>** - red  
**V<sub>2</sub>** - gray  
**W<sub>2</sub>** - orange  
**TK** - white

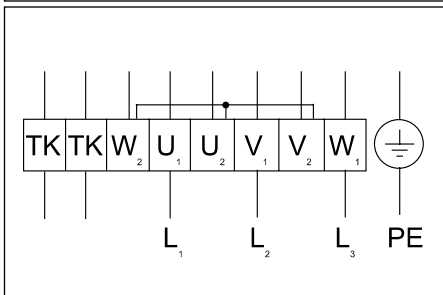

### Wiring diagram No. 2 (Y - 3~400V)

**U<sub>1</sub>** - brown  
**V<sub>1</sub>** - blue  
**W<sub>1</sub>** - black  
**U<sub>2</sub>** - red  
**V<sub>2</sub>** - gray  
**W<sub>2</sub>** - orange  
**TK** - white